

JEITA IBIS Quality WG Update

**IBIS Summit Tokyo, Japan
November 6, 2009**

**JEITA EDA-WG
Yoshihiro Hamaji (Toshiba I.S. Corporation)**

JEITA ; Japan Electronics and Information Technology Industries Association

Agenda

1. Motivation
2. IBIS Quality Framework
3. Verification of IBIS Quality Framework
4. Conclusion and Future Direction

1. Motivation - IBIS Quality issues are confusing

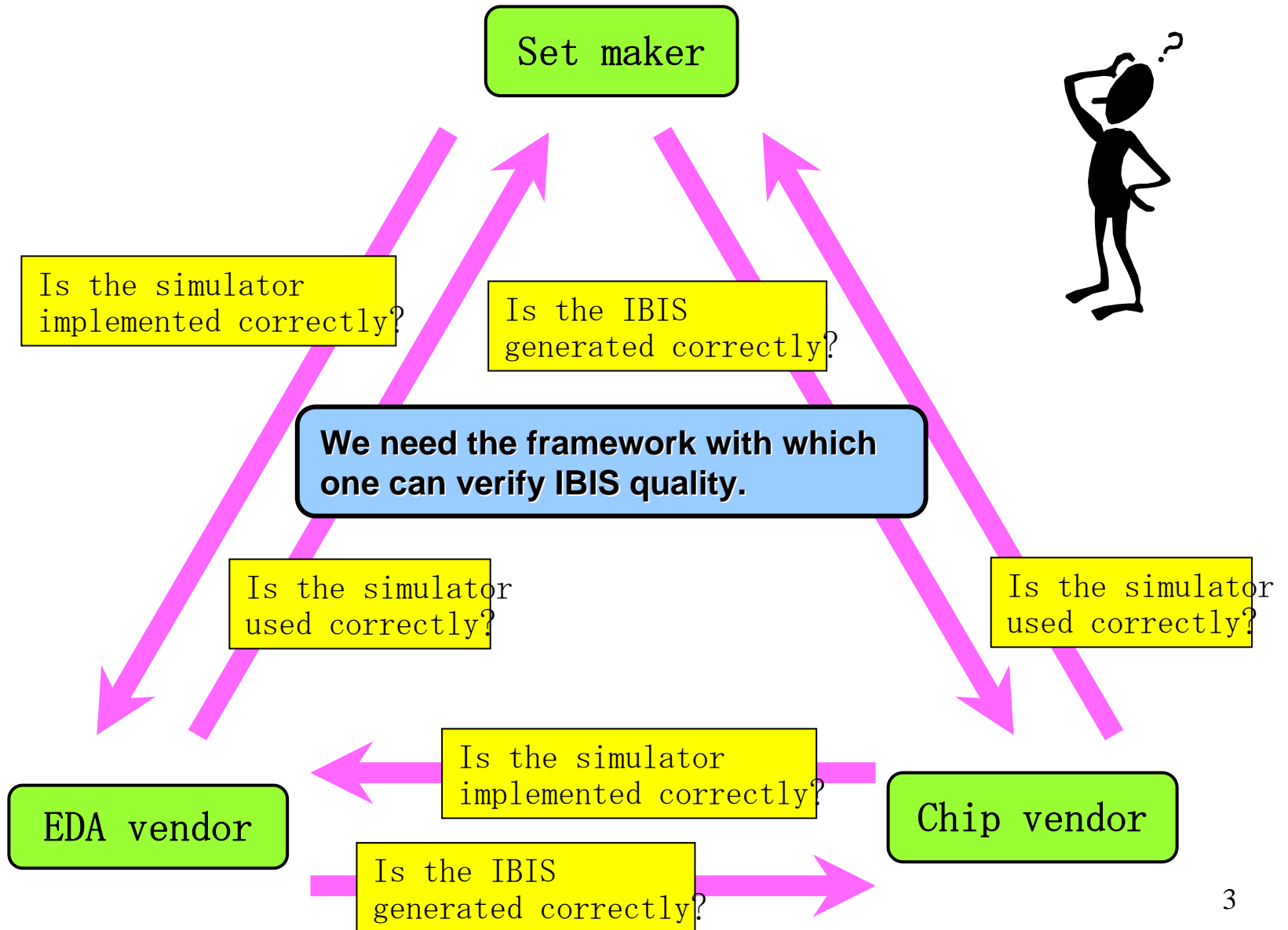



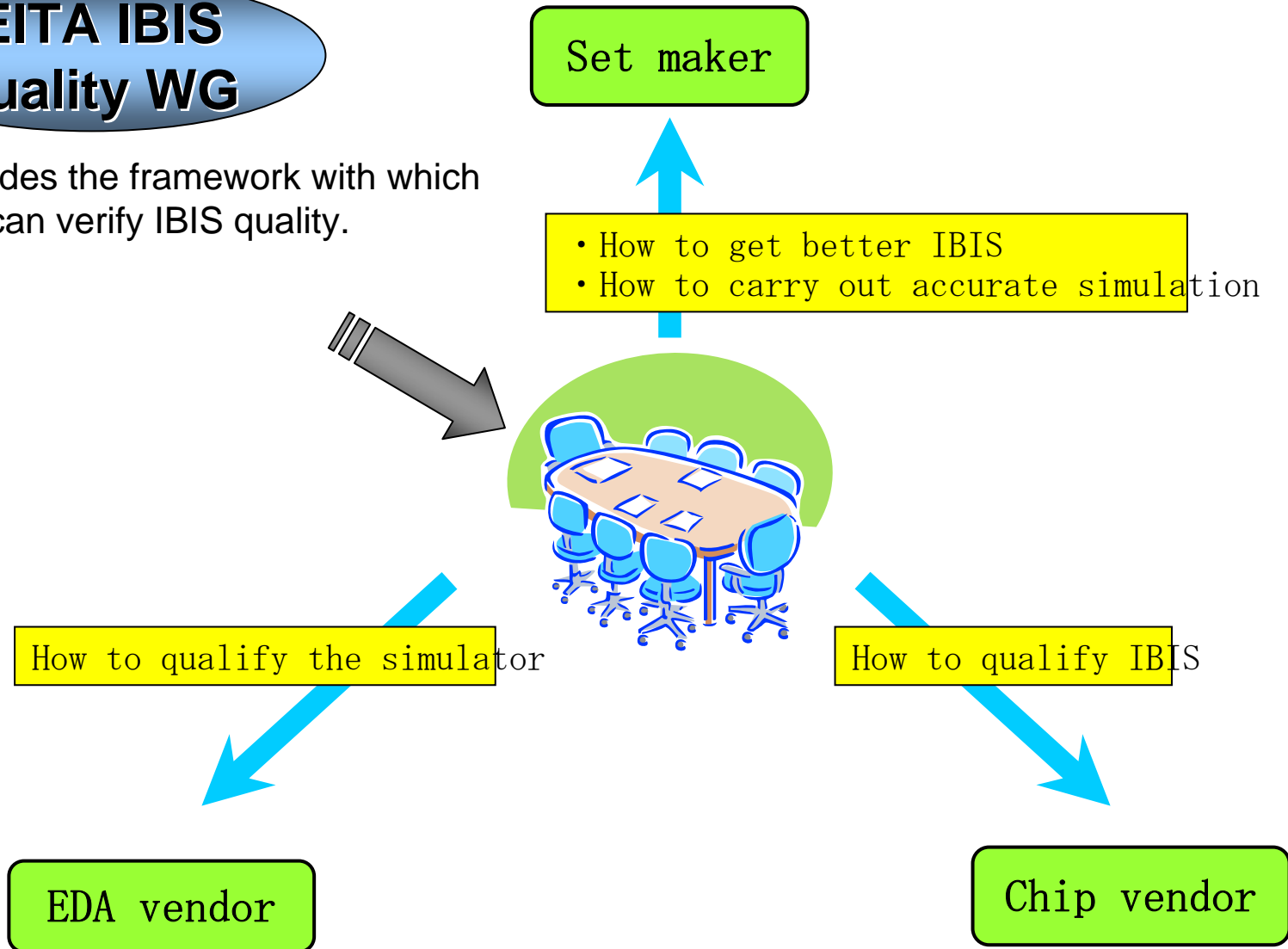

1. Motivation – The Purpose of JEITA IBIS Quality WG

JEITA IBIS Quality WG

Provides the framework with which one can verify IBIS quality.

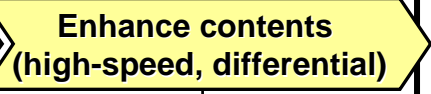

1. Motivation - Schedule

Fiscal Year		2007	2008	2009	2010	2011
Basic study of IBIS quality framework						
Verification of IBIS quality framework	Single ended IBIS model-low speed (10Mbps class)					
	Single ended IBIS model-high speed (100Mbps class)					
	Differential IBIS model					
Promotion						
					▲ Open web site (low-speed IBIS)	

Today's topic

2. IBIS Quality Framework - Definition of Qualified IBIS

- Simulation results for test circuits with qualified IBIS, qualified transmission line simulator, and qualified user, show good agreements with those of SPICE based simulator.

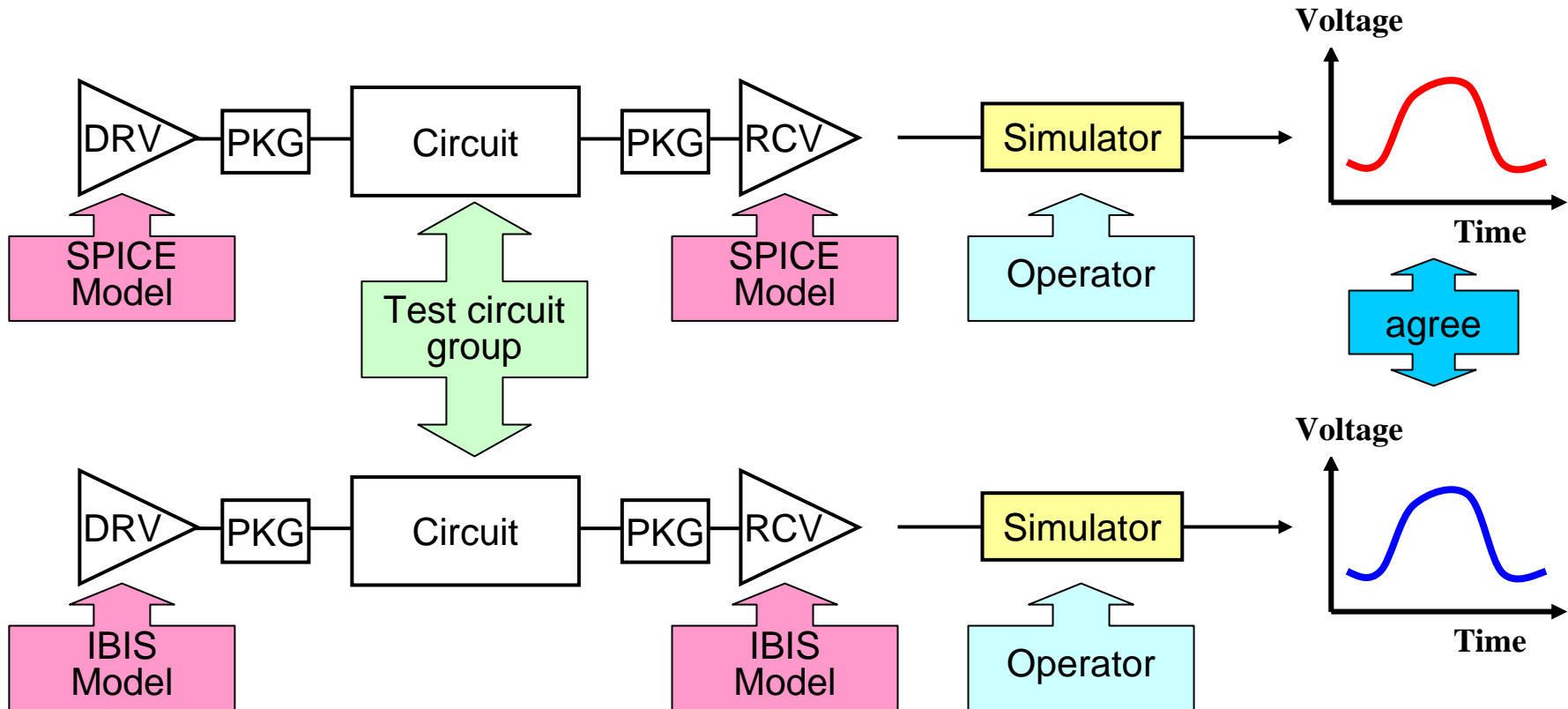

2. IBIS Quality Framework - Test circuits (1/2)

Name	Termination	Transmission line
Circuit 1	50ohm	0cm
Circuit 2	50ohm	5cm
Circuit 3	50ohm	30cm
Circuit 4	3pF	0cm
Circuit 5	3pF	5cm
Circuit 6	3pF	30cm
Circuit 7	3pF	30cm + 5cm

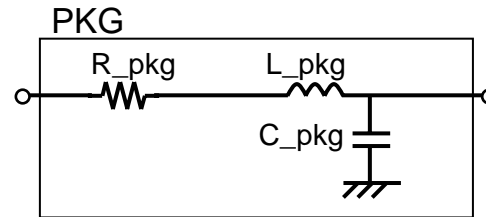

Input : PULSE
Frequency = 10MHz

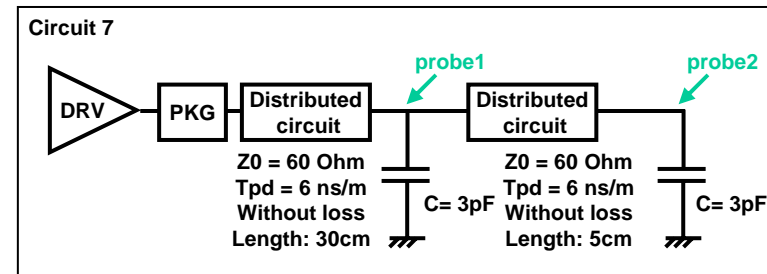
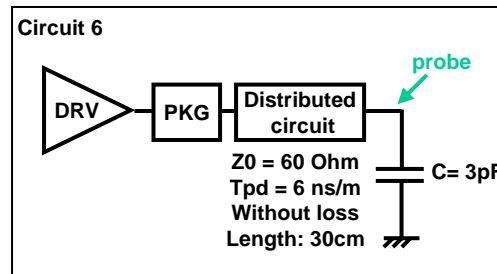
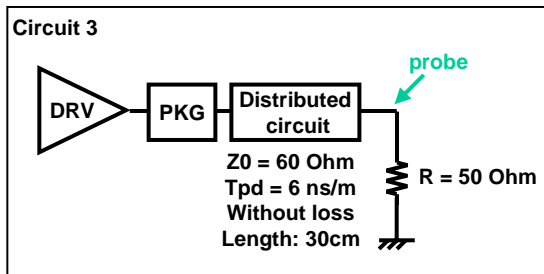
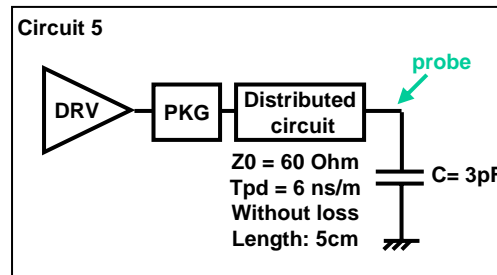
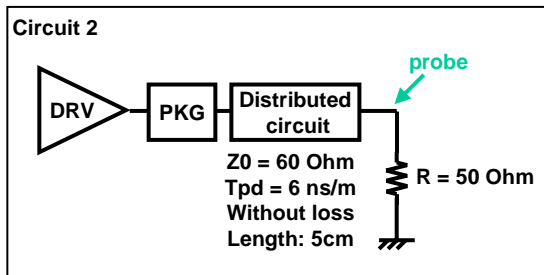
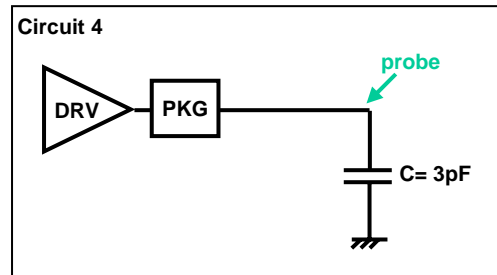
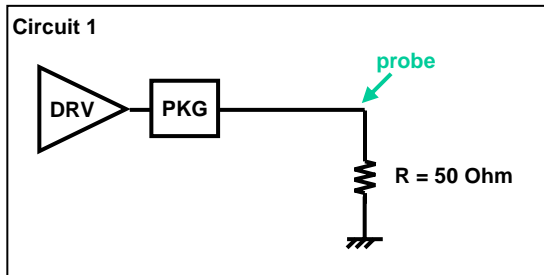

2. IBIS Quality Framework - Test circuits (2/2)

Name	Termination	Transmission line
Circuit 8	3pF	30cm + 5cm + 5cm + 5cm
Circuit 9	12pF	0cm
Circuit 10	100ohm + 100ohm	0cm
Circuit 11	10nH + 3pF	0cm
Circuit 12	3pF	5cm (Lumped circuit)

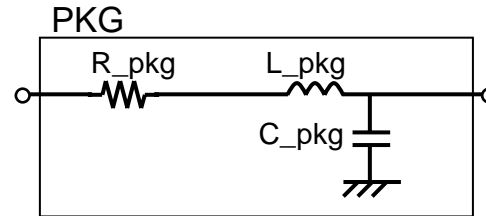

Input : PULSE
Frequency = 10MHz

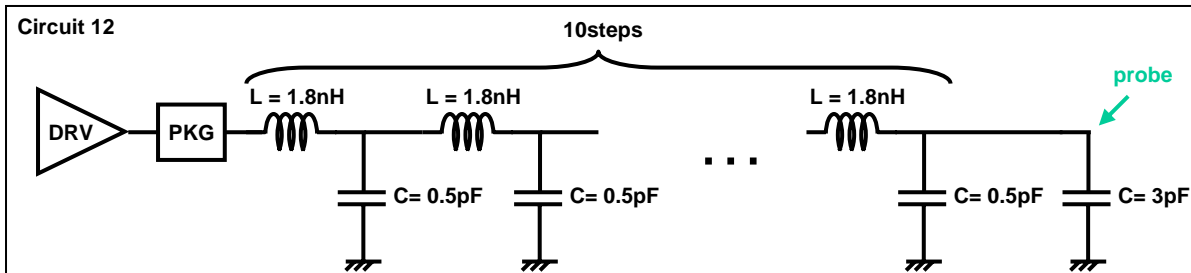
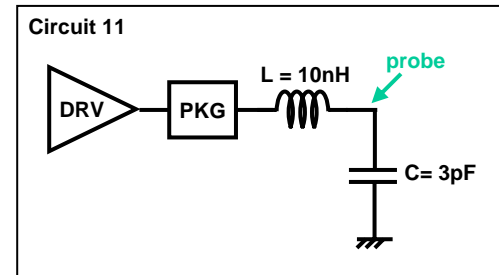
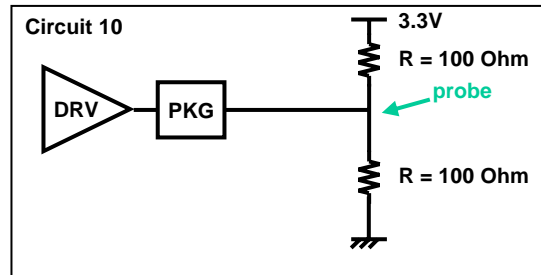
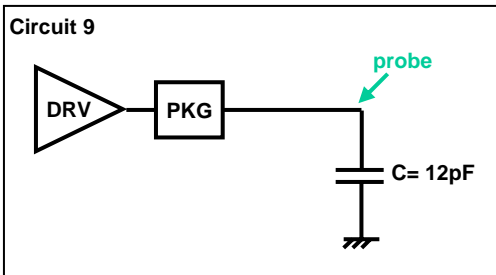
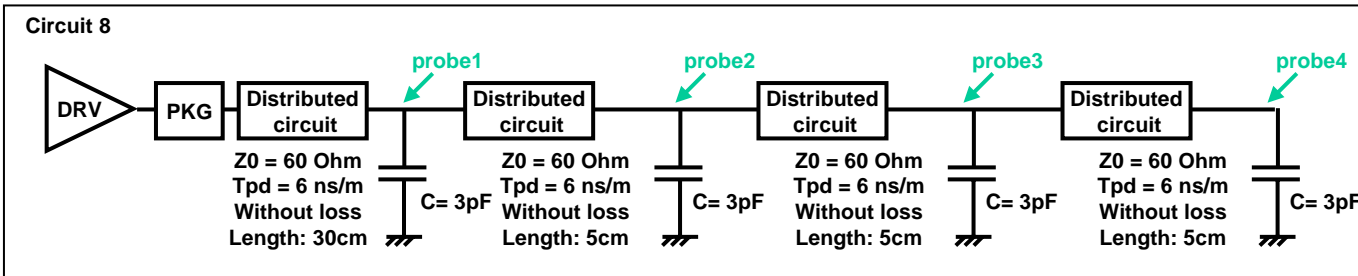

2. IBIS Quality Framework - Usage(1/4)

JEITA

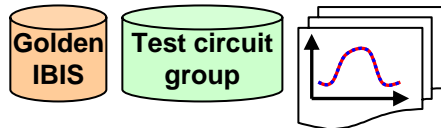

Golden results

Upload

Upload the following data to website
(1) golden IBIS data
(2) test circuit group
(3) golden results (EXCEL data)

Web
(open site)

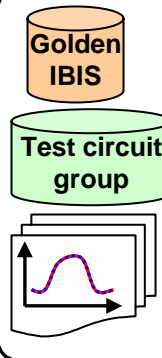

2. IBIS Quality Framework - Usage(2/4)

JEITA

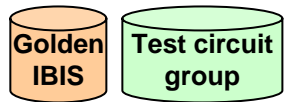

Golden results

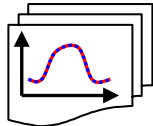

Upload

Upload the following data to website

- (1) golden IBIS model
- (2) test circuit group
- (3) golden results (EXCEL data)

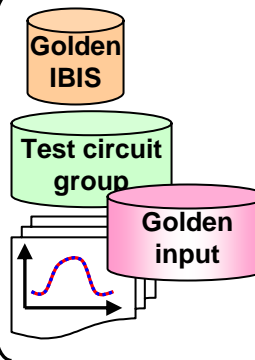

Download

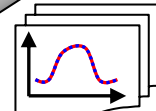

Compare

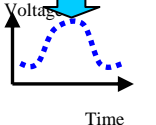

Upload

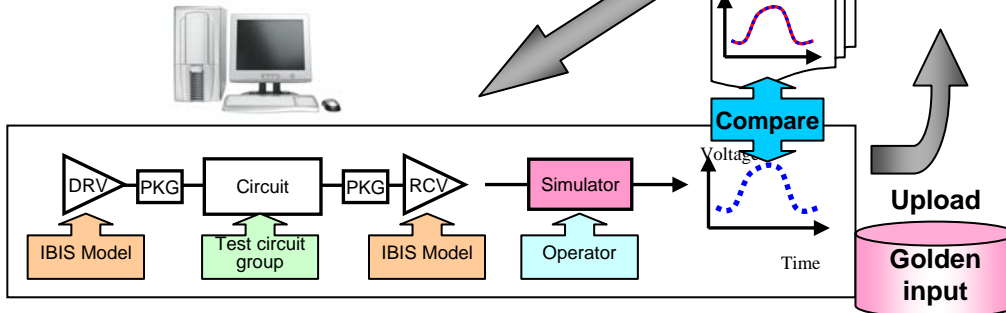

EDA vendor

Qualify the simulator

2. IBIS Quality Framework - Usage(3/4)

JEITA

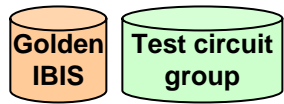

Golden results

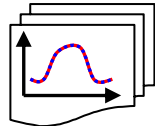

Upload

- Upload the following data to website
- (1) golden IBIS model
 - (2) test circuit group
 - (3) golden results (EXCEL data)

**Web
(open site)**

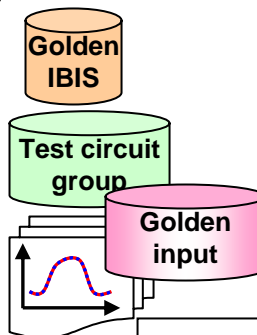

Download

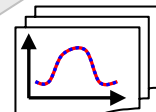

Compare

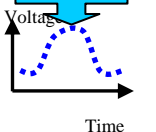

Upload

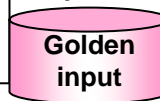

Download

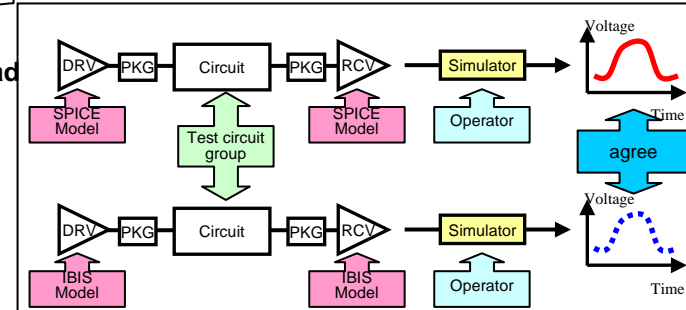

EDA vendor

Qualify the simulator

Chip vendor

• Provide the qualified IBIS

2. IBIS Quality Framework - Usage(4/4)

JEITA



Set maker

- Get the qualified IBIS
- Get the ability to carry out correct simulation

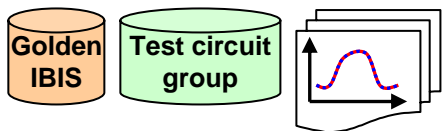
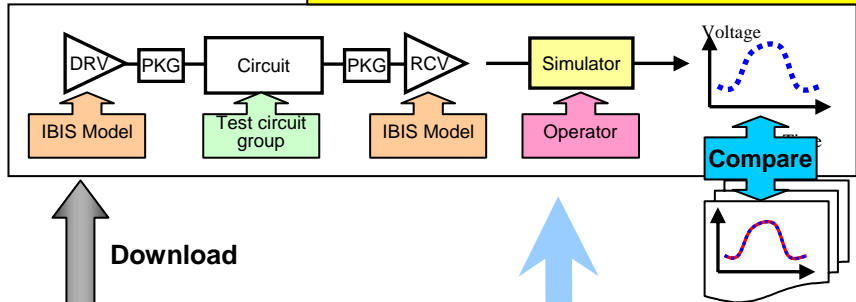

Upload the following data to website
 (1) golden IBIS model
 (2) test circuit group
 (3) golden results (EXCEL data)

Web (open site)

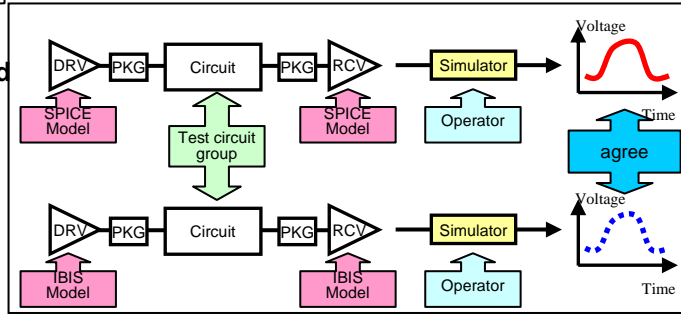
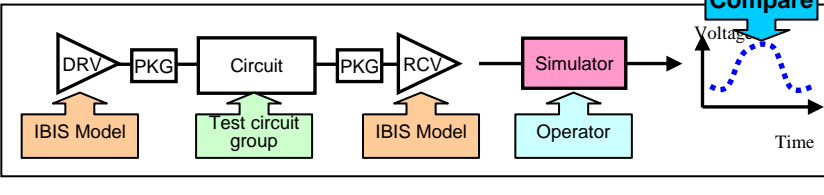
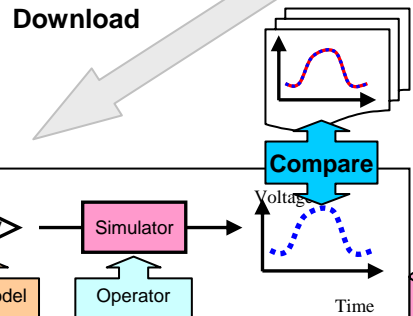
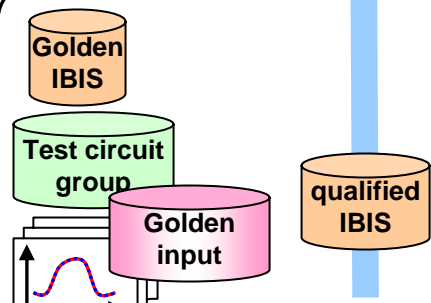

EDA vendor

Qualify the simulator

Chip vendor

- Provide the qualified IBIS
- Reduce possibility to get unreasonable claim for released

IBIS

3. Verification of IBIS Quality Framework - Method(1/6)

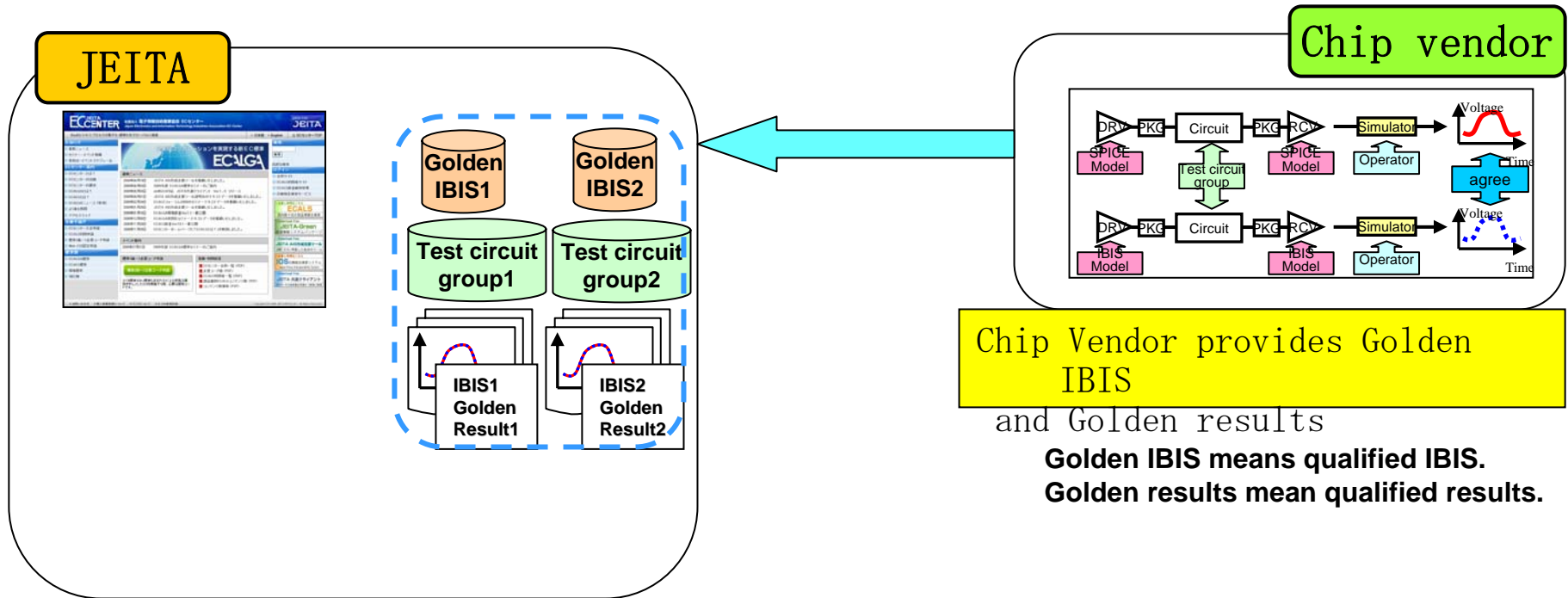

3. Verification of IBIS Quality Framework - Method(2/6)

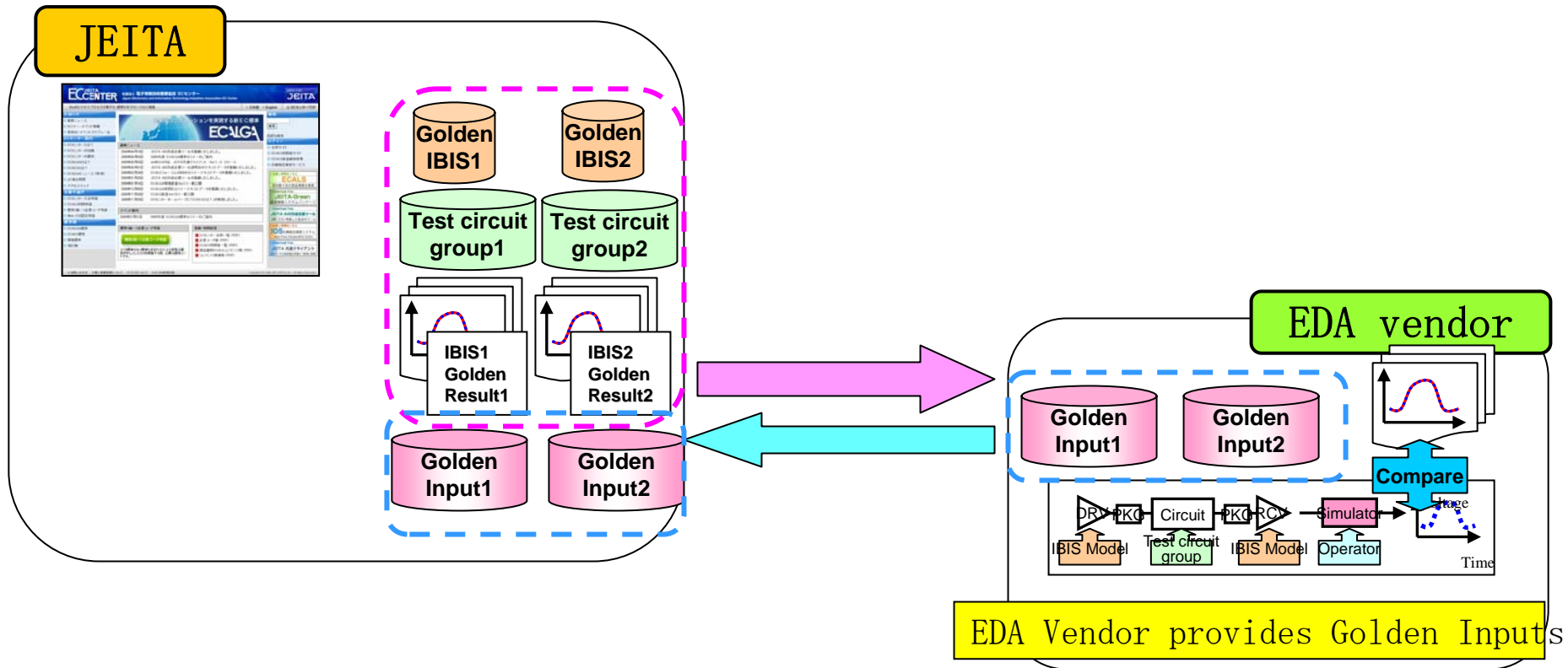

Golden input means qualified input.

3. Verification of IBIS Quality Framework - Method(3/6)

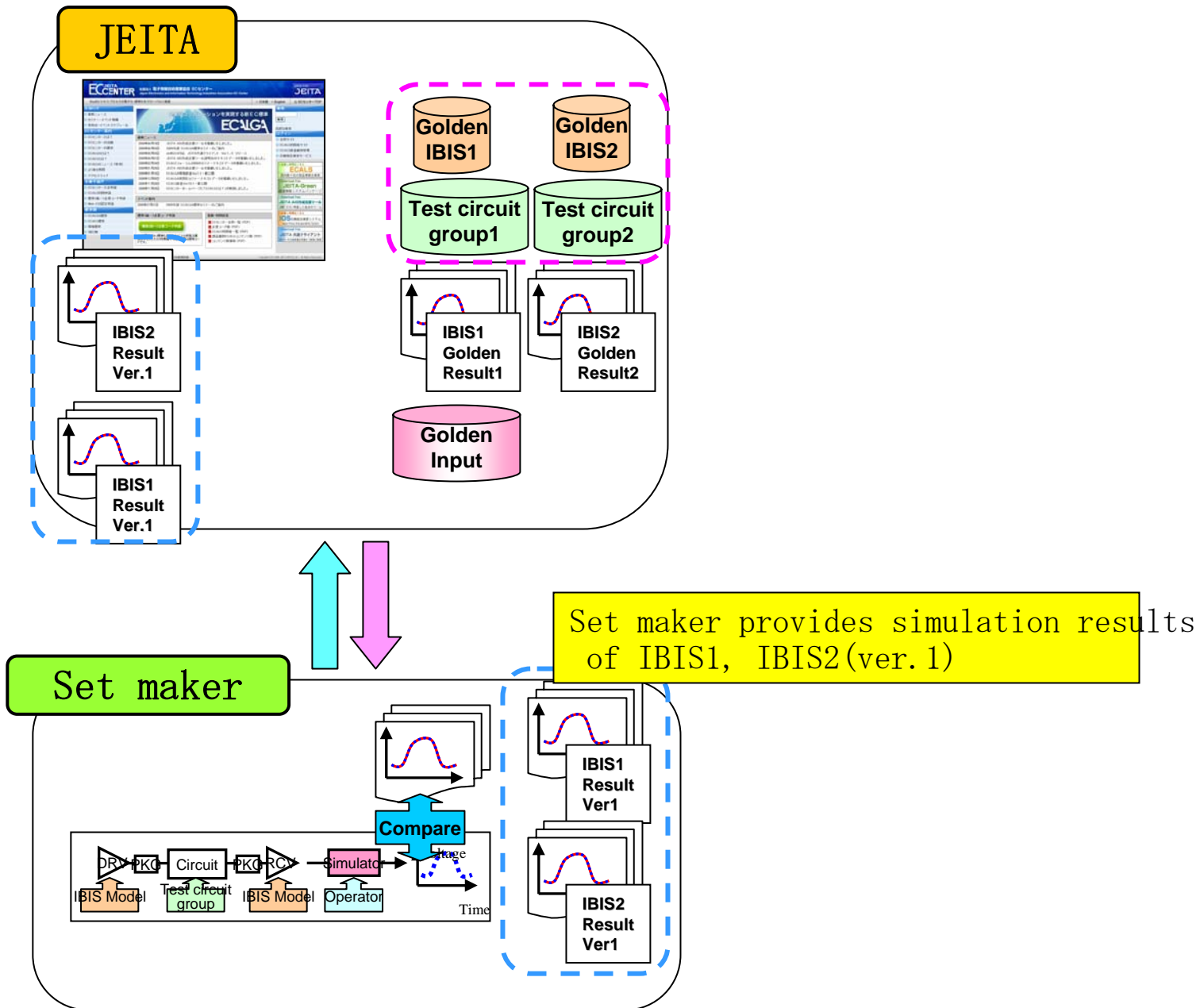

3. Verification of IBIS Quality Framework - Method(4/6)

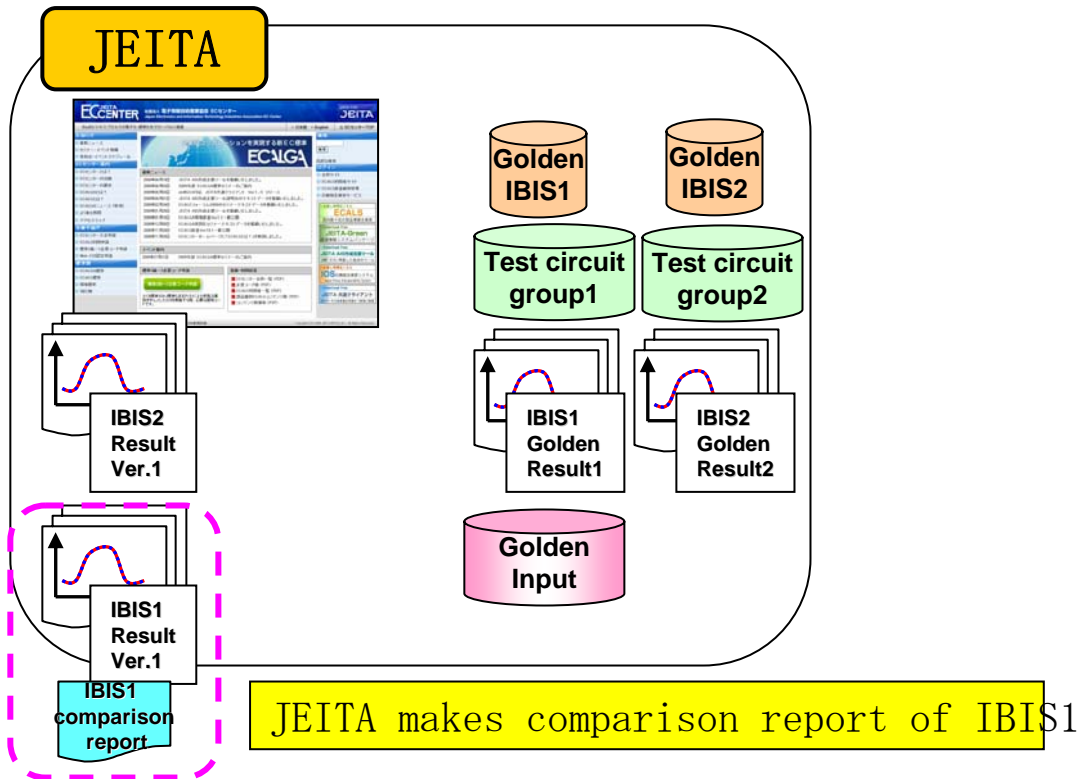

3. Verification of IBIS Quality Framework - Method(5/6)

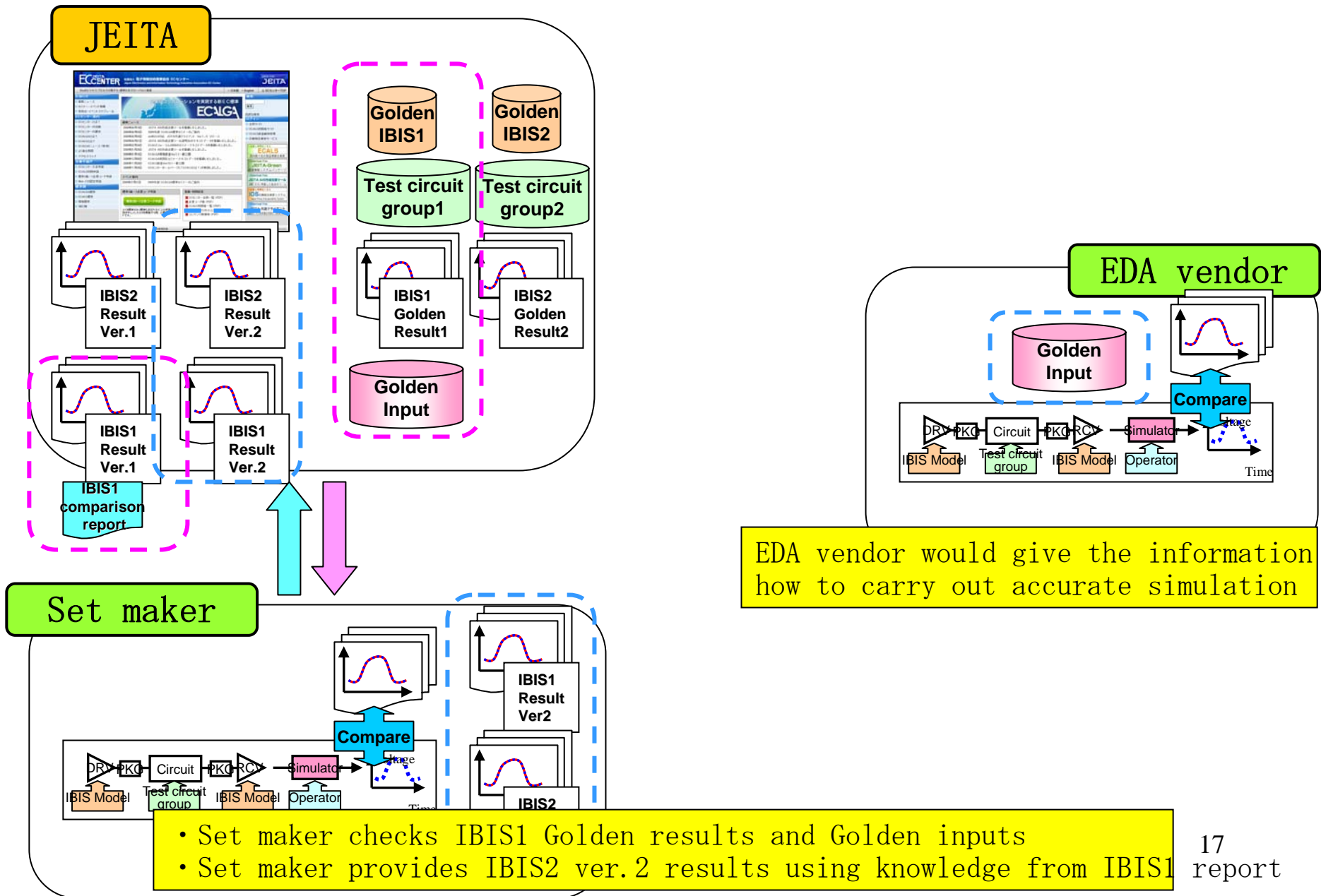

3. Verification of IBIS Quality Framework - Method(6/6)

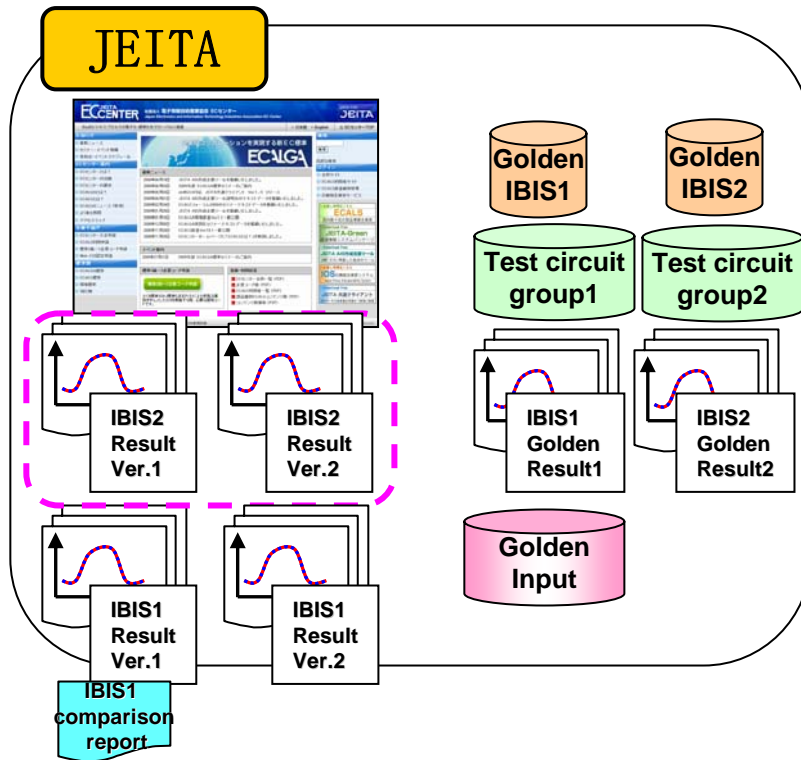

We can complete the verification of this framework by evaluating difference between IBIS2 ver.1 and ver.2.

3. Verification of IBIS Quality Framework - Result : Ver.1

IBIS2

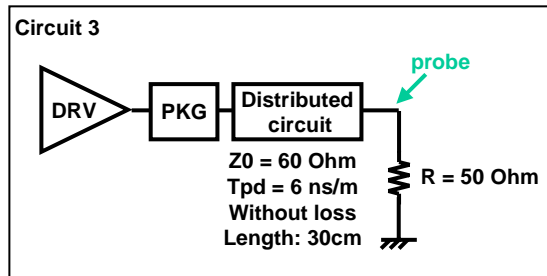

Ver.1: before using IBIS quality framework

Circuit 3

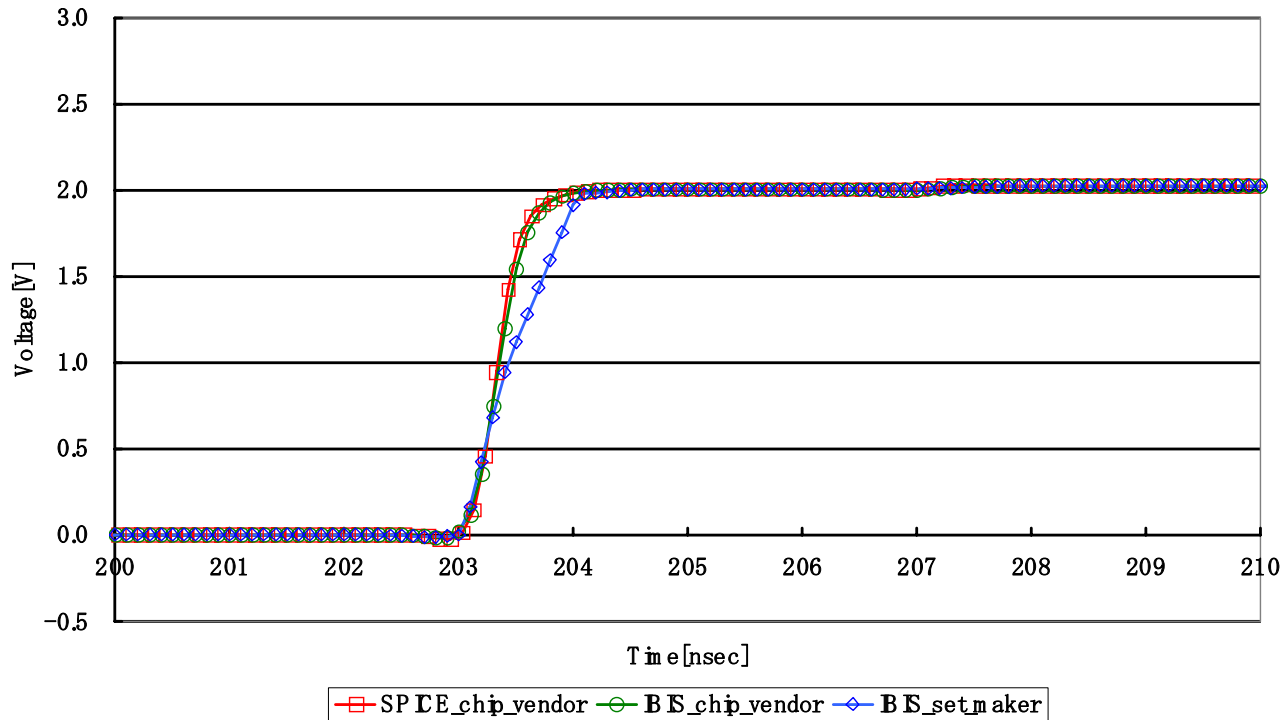

Set maker ver.1 result does not agree with chip vendor one.

3. Verification of IBIS Quality Framework - Result : Ver.2

IBIS2

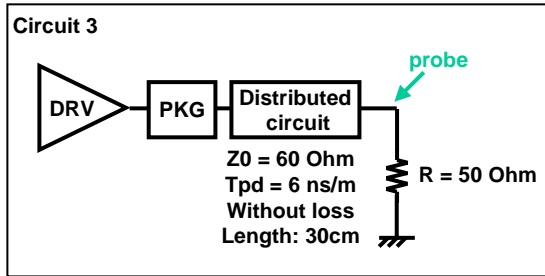

Ver.2: after using IBIS quality framework

Added simulation option

Circuit 3

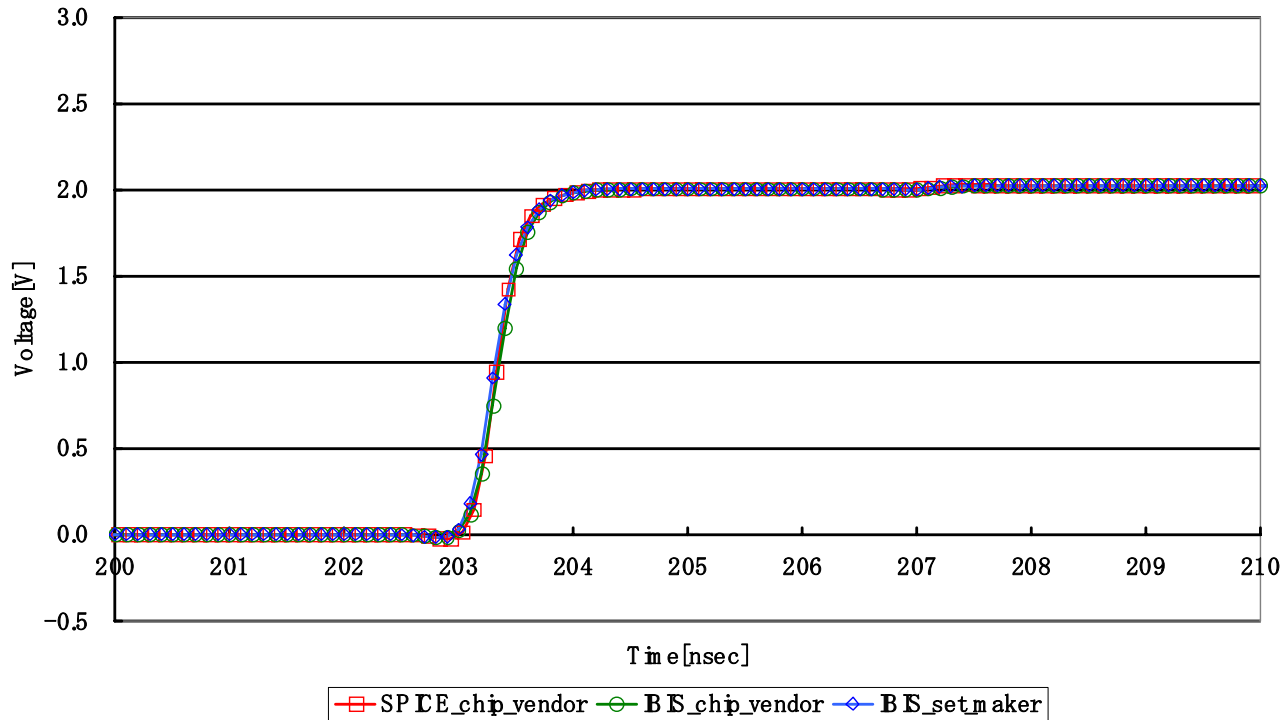

Set maker ver.2 result agree with chip vendor one.

3. Verification of IBIS Quality Framework - All results

IBIS2

○ : perfect agreement

△ : partial agreement

× : disagreement

Ver.1
(before using IBIS
quality framework)

Simulator	Circuit No.											
	1	2	3	4	5	6	7	8	9	10	11	12
Simulator A	○	○	○	△	○	○	○	○	○	○	△	○
Simulator B	○	△	△	○	○	○	○	○	○	○	△	○
Simulator C	○	○	○	△	○	○	○	○	○	○	△	○
Simulator D	○	○	×	△	○	○	○	○	○	○	△	○
Simulator E	○	○	○	△	○	○	○	○	○	○	△	○
Simulator F	○	○	○	△	○	○	○	○	○	○	△	△
Simulator G	○	○	○	○	○	○	○	○	○	○	△	△
Simulator H	○	○	○	△	○	○	○	○	○	○	△	○
Simulator I	○	○	○	○	○	○	○	○	○	○	△	○



Ver.2
(after using IBIS
quality framework)

Simulator	Circuit No.											
	1	2	3	4	5	6	7	8	9	10	11	12
Simulator A	○	○	○	○	○	○	○	○	○	○	○	○
Simulator B	○	○	○	○	○	○	○	○	○	○	○	○
Simulator C	○	○	○	○	○	○	○	○	○	○	○	○
Simulator D	○	○	○	○	○	○	○	○	○	○	○	○
Simulator E	○	○	○	○	○	○	○	○	○	○	○	○
Simulator F	○	○	○	○	○	○	○	○	○	○	○	○
Simulator G	○	○	○	○	○	○	○	○	○	○	○	○
Simulator H	○	○	○	○	○	○	○	○	○	○	○	○
Simulator I	○	○	○	○	○	○	○	○	○	○	○	○

IBIS quality framework helped users to enhance simulation accuracy.

4. Conclusion and Future Direction

- Conclusion
 - Completed the verification of IBIS Quality Framework for single-ended 10Mbps-class IBIS model.
- Near Future Direction
 - Extend the applicability of IBIS Quality Framework to other IBIS model
 - Single-ended 100Mbps-class IBIS model (ex. DDR2)
 - Differential IBIS model
 - Promote this frame work
 - Website
 - Seminar

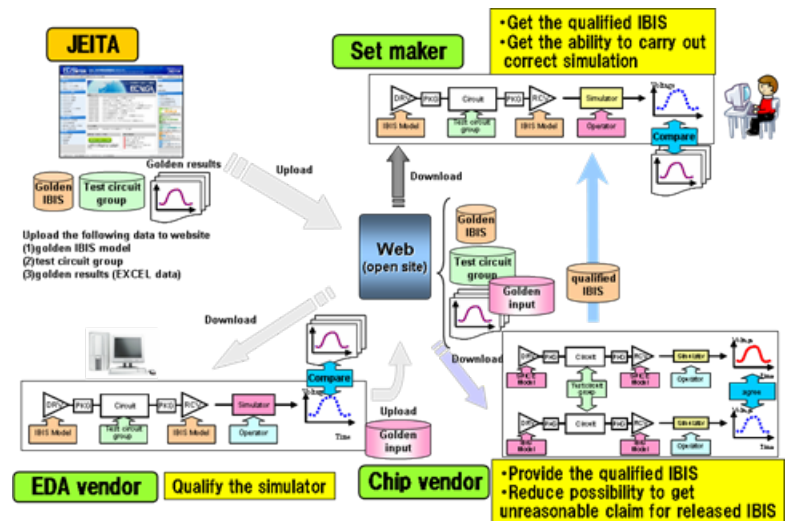

Thank you